

Haier



ULT Freezer User Manual

Model:
DW-86L100J



- Please read this manual carefully before use.
- The company reserves the right to interpret this manual.
- The product appearance depends on the actual product.
- Product technology or software x is subject to upgrade without prior notice.

Content

Precautions for Safe Operation	1
Product Features	4
Usage Precautions	5
Product Installation	6
Refrigerator Components • Control Panel	10
Usage	12
Display and Alarms	15
Cleaning and Maintenance	18
Recycle of Rechargeable Battery	20
Optional components	21
Trouble Shooting	23
Refrigeration principle and circuit diagram	24
Accessory Packing List	26
Specification	26





Precautions for Safe Operation

Dear Haier users:

Hello! Thank you for choosing Haier Biomedical. Please read this manual for safe operation and use of this product.

Safety Labels • Safety Precautions









 The upper and lower limits of temperature shall be indicated adjacent to the upper and lower horizontal lines.	 Symbol for "Manufacture"		
 Symbol for "Consult instructions for use"	 Symbol for "Date of manufacture"		
<table border="1" data-bbox="119 1003 284 1064"> <tr> <td>EC</td> <td>REP</td> </tr> </table> European Authorized Representative	EC	REP	Elscolab BV. Tolboomweg 10, 3784 XC Terschuur, the Netherlands
EC	REP		

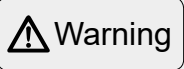

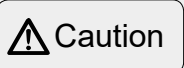
Complied with the requirements of MDD 93/42/EEC annex V

Precautions for safe operation

 Warning	Failure to observe WARNING signs could result in a hazard to personnel possibly resulting in serious injury or death.	 Actions or operations which are prohibited
 Caution	Failure to observe CAUTION signs could result in injury to personnel and damage to the unit and associated property.	 Actions or operations which must be followed

-  When CO₂/LN₂ backup is activated, the location place must be well ventilated. Increased CO₂ in the air may be harmful and even fatal. If the ventilation is poor, other methods should be considered in order to ensure safe working environments.
-  If there is a leakage of petroleum gas or other flammable gas, close the gas supply valve and open doors and windows to ventilate the air. Do not plug or unplug your freezer unit in order to avoid potential explosion or fire.
-  Only professional technicians or service personnel can install the unit. Failure to do so may cause electric shock or result in a fire hazard.

- ! The freezer must be securely installed on a firm floor. On an uneven surface may result in the product tipping over thereby causing injury and damage.
- ! Please use the dedicated power supply marked on the product label to avoid fire and electric shock.
- ! If the voltage being used is 10% higher than the rated voltage, a regulator with a capacity of 4000 W or higher must be installed.
- ! If the power cord needs to be extended, the cross-section of the extended cable must be no less than 14Awg and no longer than 9ft for products of 220V~240V/50Hz or 220V~/60Hz and no less than 12Awg and no longer than 3m for products of 115V~/60Hz to avoid fire or electric shock.
- ! Your ULT unit is equipped with a standard three-prong power plug (grounded) complying with the standard three-prong socket (grounded) rated 10A .Removal of the ground prong be securely plugged into the socket. A loose plug in the socket may cause fire.
Never install your ULT in an unprotected area. If the unit is exposed to moisture, there is a danger of electric shock.
- ! Your ULT must not be installed in a damp area or an area subjected to water spray, as may reduce the degree of insulation and thereby cause electrical leakage or electrical shock.
- ⊘ Never directly pour water into the unit. The water may cause electrical shock or short circuit.
- ⊘ Do not place heavy objects on top of the unit, as a falling object may cause injury.
- ⊘ Never use gas lines, water mains, telephone lines or lightning rods as the grounding device for you ULT unit. This type of improper grounding may cause electric shock or other danger.
- ⊘ Do not touch any electrical components, switches or power cord with wet hands. Such action may lead to electric shock.
- ⊘ When unplugging the power cord from the socket, please grip the plug itself and pull it out. Do not pull on the power cord as this may strip the wires out of the plug thereby causing electric shock and fire.
- ⊘ Should there be any Malfunction in the equipment, power off the unit and unplug the power cord from the power supply. Continues operation in an abnormal condition may result in electric shock and fire.
- ! User must not dismantle, repair or modify the equipment. Such operations may result in fire or personal injury.
- ! Before any repair and maintenance of the freezer, please disconnect the power to avoid electric shock or injury to personnel.
- ⊘ When repairing and maintaining your freezer, take precautions not to inhale any chemicals or aerosols floating inside and outside the unit. They may be harmful to your health.
- ! If the unit is not to be in use for a long period of time, make sure the power cord is unplugged.
- ! Deteriorated insulation of the power cord may lead to electric shock or fire.
- ! The freezer needs to be disposed by specialized personnel.
- ! Do not use nay unapproved electrical components with the freezer.

-  Never store flammable, explosive or volatile materials in the unit, nor use any flammable spray near the unit, as this may cause an explosion or fire.
-  Never store corrosive chemicals with acid or alkaline properties in the unit, as this can lead to damage to internal components of the unit.
-  Do not use any glass containers with the unit. These containers may crack at low temperatures and cause injury.
-  Do not climb on top of the unit or place any object on it. Falling equipment may cause injury or property damage.
-  Do not use any hard objects such as nails and wires in opening or gaps such as air ventilation ports. Accidental contact between a hard object and a moving part may result in electric shock or injury.
-  After restarting your unit from a power outage or shutdown, ensure that all settings are correct. Accidental changes in settings may damage the stored products.
-  In the event of a power outage and recovery, wait for at least 5 minutes before turning the unit on again to avoid damage to compressors and refrigeration system.
-  The air filter for the condenser should be cleaned regularly. A dirty filter could cause a malfunction or the freezer temperature to rise.
-  During any repair operations, gloves should be worn to prevent getting injured by sharp edges or corners.
-  Do not use bare hands to directly handle any stored products. The cold temperature of products and the interior walls may cause frostbites.
-  Do not tilt the unit more than 45 degrees when moving it.
-  When moving the unit, please be cautious not to cause injury to personnel or damage the unit.
-  Do not attempt to use the handle to lift or move the unit to avoid damaging the freezer or injuring personnel.
-  We recommend the unit be installed and maintained by a professional to avoid any electrical hazard. The replacement of any spare parts (battery ect.) shall be conducted by technicians approved by manufacturer.
-  Keep all ventilation openings in the enclosure or, in the structure for building-in, clear of obstruction.
-  Do not use mechanical devices or other means to accelerate the defrosting process, other than those recommended by the manufacturer.
-  Do not damage the refrigerant circuit.
-  For equipment which use flammable insulation blowing gases, the instructions shall include information regarding disposal of the equipment.
-  The instructions for split-systems that use a flammable refrigerant shall include the substance of the following warning:
-  In order to reduce flammability hazards the installation of this equipment shall only be carried out by a suitably qualified person.

Product Features

This product can be used by clinical, pharmaceutical, scientific research, quarantine departments, etc. for the preservation of articles under low temperature and by blood stations, hospitals, centers for disease control and prevention, scientific research institutes, electronic chemical engineering and other enterprise laboratories, biomedical engineering research institutes, ocean fishing companies, etc. for the preservation of red blood cells, white blood cells, viruses, germs skin, skeletons, bacteria, seminal fluids, biological products, electronic devices, special materials, etc. under low temperature.

1. Temperature control

Temperature is controlled by computer and numerically displayed and regulated in units of 1°C; temperature range: -40°C to -86°C.

2. Safety system

- Various malfunction alarms (high temperature alarm, power failure alarm, probe failure alarm, hot condenser alarm, high ambient temperature alarm, doors open alarm, low battery alarm).
- Two types of alarms (Buzzer sounding alarm, Flashing light alarm).
- Protective functions (password protection, power up delay protection).
- All independent components are safely grounded.

3. Refrigeration system

- Optimized auto-cascade refrigeration technology and imported compressor, ensuring stronger refrigeration capacity.
- High-performance insulation layer, ensuring excellent thermal insulation effect.
- Unique multi-layer door sealing structure and anti-condensation heating technology, effectively reducing frosting.
- Scope of application: applies to the preservation of articles by clinical, pharmaceutical, scientific research, quarantine departments, etc. under low temperature.
- 810mm cabinet, placeable under the laboratory bench, saving the storage space.

4. Ergonomic design

- LED display screen, showing temperature inside the box, ambient temperature and input voltage, settable high/low temperature alarm and temperature inside the box, having fault warning function.
- Adjustable shelf design, convenient for storage of articles.
- Safety door lock to prevent opening at will.
- Wide climate zone design, suitable for the environment ranging from 10°C to 32°C.
- “Innovative” integration of lock and handle and compact caster design, ensuring flexibility and convenience.
- Intelligent condenser fan start and stop, saving energy effectively.
- Advanced and practical network and remote warning.

Not all models have all features mentioned above. For specific features, please refer to the specification table of each specific model. Due to the product improvement, the Haier cryopreservation box you get may not be completely consistent with the illustration in the manual. We sincerely apologize for this. The contents of this manual are subject to changes without notice.

Usage Precautions

- When the unit operates normally, the unit frame at the front near the door may be slightly warm; This phenomenon is normal because hot tubing is embedded there to prevent condensation from forming on the frame.
- Before samples are loaded into the unit, make sure the unit temperature has reached the set point then load the samples into the freezer in batches. Each batch should not exceed 1/3 of the unit capacity, so that the temperature does not rise while samples are being loaded.
- The temperature display indicates the temperature from the sensor location inside the unit chamber, which may vary from the temperature at the center of the freezer but will gradually reach the actual temperature of the freezer over time.
- Two access ports are installed in the back wall of the unit which can be used as the pass-thru for thermocouple wires during testing and validation. Once all test wires are through the access port, make sure that the gap in the port is sealed properly with insulation materials. Failure to seal the access port may affect the operation of the unit. The port ring in the outer wall can also accumulate frost and ice.
- When cleaning the unit, mild or neutral detergent solution should be used. Never use a hard wire brush, acid, gasoline, powder detergent, polishing powder, or hot water to clean the freezer, as these tools and materials can damage the paint coating and plastic components. Never use gasoline or solution with volatile chemicals to clean plastic or rubber parts.
- After the freezer runs for some time, a layer of frost usually forms on the interior liner and inner doors. When this layer of frost becomes too thick, it can negatively impact the refrigeration performance of the unit. Energy consumption can increase. If the thickness reaches about 5 mm/3/10in, use the supplied scraper to remove the frost.
- Before removing the frost, temporarily transfer the stored samples to another freezer to prevent rising temperature from damaging the samples.
- Behind the interior walls, there are many refrigeration lines. Do not use a knife, an ice pick, or a screwdriver to cut ice and frost. This may damage not only the liner but also the refrigeration tubes.
- If the freezer is not in use for a period of time, turn off the power and backup battery. The power cord should be unplugged.
- Basic performance claimed by the EMC test: the basic performance of the box is that the refrigeration system can work normally.
- The temperature cooling function inside the box can be achieved.
- Electromagnetic compatibility requirements:
 - a) This machine complies with the emission and immunity requirements specified in EN 61326-1.
 - b) This machine is designed and tested as Class A equipment specified in CISPR. In domestic situations, this machine may cause radio interference and protective measures shall be taken.
 - c) It is recommended to evaluate the electromagnetic environment before using the machine.
 - d) It is prohibited to use this machine near strong sources of radiation (such as unshielded video sources), otherwise it may interfere with normal operation of this machine.

Product Installation

Installation environment

- Ambient temperature: 10°C to 32°C. The ideal temperature is 18°C to 25°C. If necessary, use an air-conditioning system to achieve the requires ambient condition.
- Environment humidity: less than 80%RH. At an environment of 32°C, humidity should be less than 57%RH.
- Avoid large amounts of dust.
- Avoid mechanical swing or vibration.
- Highest recommended elevation for safe usage: 2,000m above sea level.
- Input voltage: rated voltage \pm 10%.
- The transient state is Category II facility(overvoltage category).
- Pollution Degree:2.



- An ULT is sensitive to its operating environment. If a unit is not installed in the conditions mentioned above, it may not operate reliably.
- The unit is intended for indoor use only.

Installation site

For the equipment to achieve optimal operating conditions, an intended installation location should satisfy the following requirements.

- Do not install the unit in a confident space. The doorway should be large enough for the unit to freely be transferred in or out of the room if necessary. This is to allow the unit to be repaired easily and timely to avoid damage to property.
- The location for installation should be flat and firm.
- There should be good ventilation and no direct sunlight.
- The freezer unit cannot share the same power socket with other equipment. The power plug should be securely connected to the power socket.
- The power cord for the freezer should not be twisted or pinched.
- If the power cord needs to be extended, the cross-section of the extended cable must not be no shorter than 2mm(14 gauge wire) and no longer than 3m(9.8ft).
- Before using the freezer, check the voltage supply. A voltage stabilizer to deliver rated voltage \pm 10% is recommended for areas in which the voltage is known to be unstable. The voltage stabilizer should be rated at least 4000W.
- The freezer must be grounded.
- If the power socket is connected with a ground terminal, make sure to inspect it for proper connection before using the equipment.



- Do not ground the freezer through gas lines, water mains, telephone lines and lightning rods, as this may lead to electric shock.
- After installation, the power plug must be easily accessible to unplug in case of an emergency. Nothing should block ventilation port of the freezer.

■ Preparation before use

1. Remove packing materials and straps.

- Remove all packing materials and straps for transportation.

2. Check the supplied accessories

- Check the items in the packing box according to the packing list. If they do not match each other, please contact manufacturer.

3. Placement condition

- Reserve at least 30cm of clearance around the refrigerator for ventilation.

4. Adjust Leveling legs

- Rotated the leveling legs clockwise to extend them out to level the unit to the floor and ensure that the unit does not move while in use.

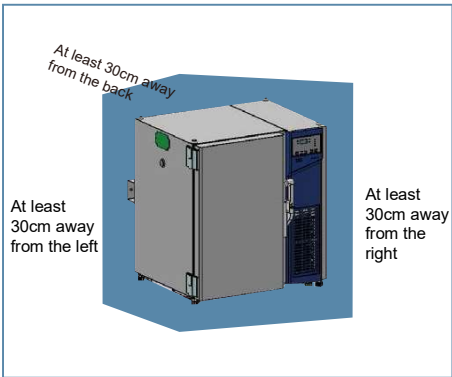

5. Standing

- After adjusting and cleaning the unit, do not immediately connect the power cord. The freezer needs to be placed in its intended location for at least 24 hours before connecting the power to ensure it will operate normally.

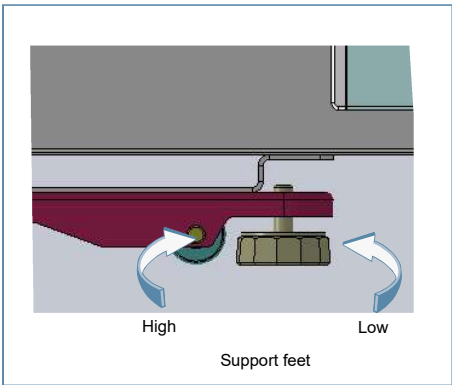

6. indoor use; not use in wet condition.



- To handle the freezer before unpacking, forklift or package carrier may be used. If the forklift is used, it shall be inserted at the bottom of blocking from the front or back of the freezer to move the freezer. If the package carrier is used, it shall pick up at the bottom of blocking and can only pick up the side of the freezer.
- After unpacking, to handle the freezer, you may push wheels for handling.
- During handling, the inclination angle of freezer shall not be greater than 45°.
- Please be careful to slip while pushing the Freezer.

Power on for the first time

When the unit is started for the first time, please follow the procedures below.

① while keeping the unit empty, plug in the power cord to dedicated power socket that meets all electrical requirements.

② Connect the freezer to the power supply, turn on the power switch located on the side of the freezer (as in the illustration on the right), and then turn on the battery switch.

③ If the unit has a backup cooling system (optional) turn off the backup system.

④ Set the unit to desire temperature: Do not load the unit with any samples. Power up the unit to let it run down to -60°C . Let it run at -60°C for 8 hours then lower it to -80°C . Observe the unit performance for 24 hours for normal cycling to ensure that it is working properly.

⑤ Once the unit is confirmed to be operating properly, it is ready to be loaded with samples. In principle, the freezer unit should be set at about 3°C above the desired temperature. For example, if the storage temperature is -60°C , set the unit at -57°C . Load the unit with samples in batches of less than $1/3$ of the unit's capacity. Make sure that the unit is capable of cycling for more than 8 hours.

⑥ If the unit has a backup cooling system (optional), turn it on.

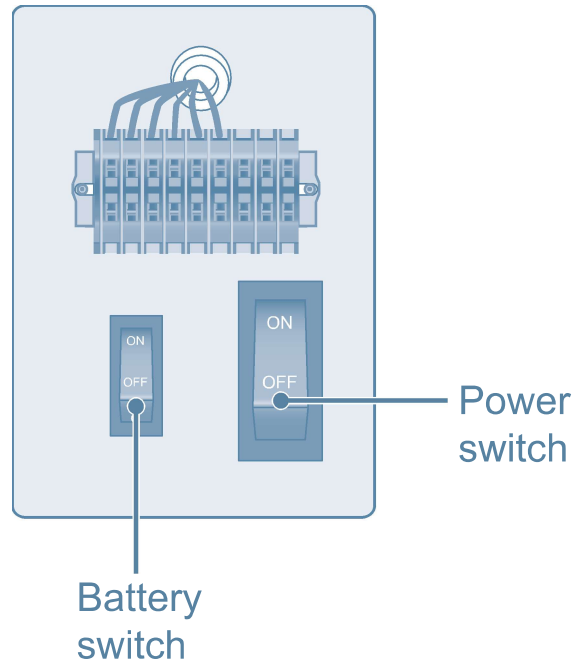

- Your ULT unit should be cared for by trained personnel. Every 2 to 4 hours, the Unit's working status should be inspected and recorded on a daily basis. Should there be a malfunction in the unit, the freezer temperature rises. If the problems cannot be corrected in a short time, please remove the stored samples, move them to another unit that meets the temperature requirements to avoid potential damage to samples.
 - Before putting samples in the freezer to be stored, first check that the freezer's temperature is at the desired setpoint to prevent damage or loss.
 - All ultra low temperature storage units are low temperature storage equipment.
- It is not recommended to load excessive amounts of samples into the unit at one time. Overloading may result in inadequate performance. The freezer and the compressors can become overheated.
- Samples must be loaded in batches, while gradually decreasing temperature setting. The process should be repeated until the final temperature is reached.
- Do not use any unauthorized mechanical tools or other means to accelerate the defrosting process.
 - Do not damage the refrigeration circuit.
 - Do not use any unapproved electrical components in the freezer.

■ Operation after a Power Outage

Your ULT freezer control settings are stored in its memory system. Should there be power outage and recovery, the unit can resume its operation based on the previous settings.

-  **Warning**
- In the level of a power outage and recovery, be sure to wait for at least 5 minutes before turning the unit on again to avoid damaging the compressors and refrigeration system.
 - If the unit is not in use for a long period of time, make sure the power cord is unplugged. Deteriorated insulation of the power cord may lead to electric shock or fire.

Refrigerator Components • Control Panel

Refrigerator Components



Control panel

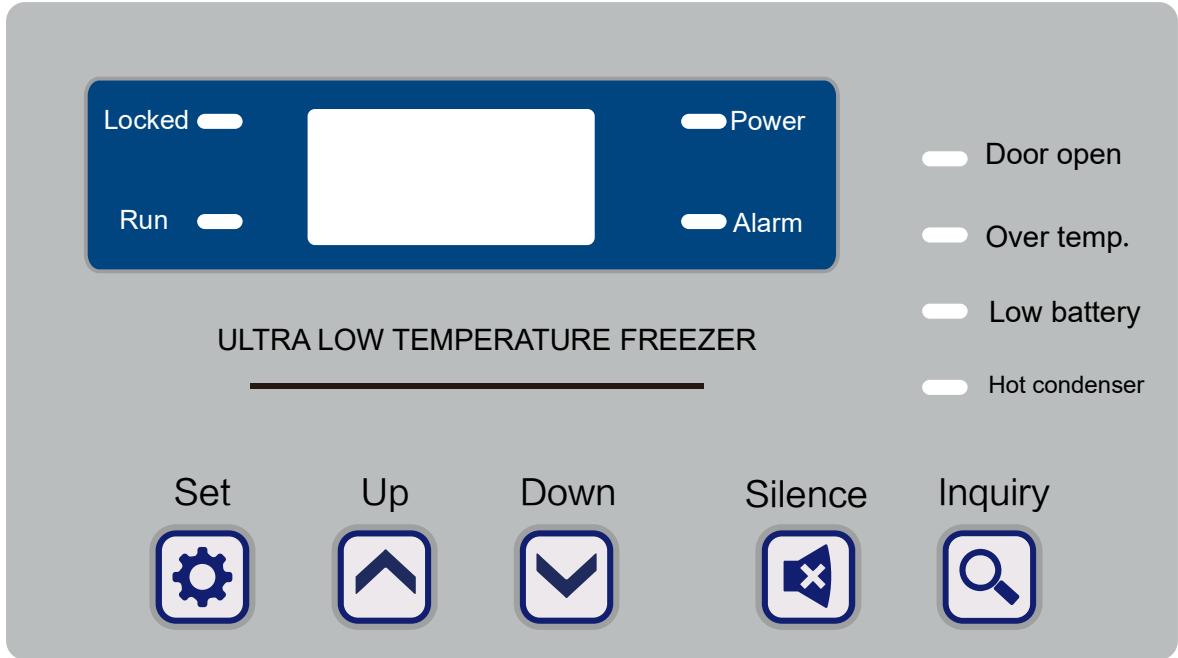

Usage

■ Unlocking method

1. Press “Up” or “Down” to “06”;
2. Press and hold “Set” for 5 seconds to make “Lock” light off to enter unlock state and carry out various settings;
3. Press “Set” to select “TS” temperature setting inside the box, “ALH” high-temperature alarm setting, and “ALL” low-temperature alarm setting in a circular manner;

■ “TS” method

1. Under the unlock state, press “Set” to select the “TS” and make current set temperature inside the box flash;
2. Press “Up” or “Down” to adjust the set temperature inside the box;
3. After completion of modification, press “Set” to save set temperature inside the box and return to display TS;

■ “ALH” setting method

1. Under the unlock state, press “Set” to select the “ALH” setting and make current set ALH value flash;
2. Press “Up” or “Down” to adjust the set ALH value;
The modification scope shall be set temperature inside the box + 5°C ~ 0°C.
3. After completion of modification, press “Set” to save set ALH value and return to display ALH;
If there is no key operation for 20 seconds, the set ALH value is not saved, and after function lock, the temperature inside the box is displayed.

■ “ALL” setting method

1. Under the unlock state, press “Set” to select the “ALL” setting and make current set ALL value flash;
2. Press “Up” or “Down” to adjust the set ALL value;
The modification scope shall be -99°C ~ set temperature inside the box - 5°C;
3. After completion of modification, press “Set” to save set ALL value and return to display ALL;
If there is no key operation for 20 seconds, the set ALL value is not saved, and after function lock, the temperature inside the box is displayed.

Remarks: ALH and ALL values are related to the TS values. If the temperature inside the box is changed, the difference of ALH and ALL values from temperature inside the box shall not change. If ALH and ALL values are changed, temperature inside the box shall not be changed.

■ User parameter adjustment

Under the unlock state, press and hold “UP” for 5s to enter the user parameter settings, and press “UP or “Down” to select 7 parameters including dA, T1, T2, P6, IC, PS1 and CL1. Press “Set” after selecting one parameter to modify this parameter;

1. dA: door opening alarm delay, with default of 5min, adjustable from 1 to 30min;

Press "Up" or "Down" key to modify the set value of door-opening alarm delay;

2. T1: The USB fetch cycle defaults to 6min, which is adjustable in 1 ~ 99min;

Press "Up" or "Down" key to modify the set value of usb fetch cycle;

3. T2: USB time, Year (P1:10 to 99) / Month (P2:01 to 12)/Day (P3:01 to 31)/Hour (P4:00 to 23)/Minute (P5:00 to 59);

Press “UP or “Down” to modify the set usb time;

4. P6: USB derivative mode, with the default of 12, adjustable from 0 to 12;

The data can be exported in different periods, the parameters 0 ~12 can be set, and the default value of 12 means the one year of data can be exported once; setting it to 0 means exporting all the data once, setting it to be 1 - 12 means respectively exporting the data of several months before the current time, such as the data of 2 months, 3 months... 12 months.

Press “UP or “Down” to modify the set USB derivative mode value;

5. IC (optional): IC card registration password modification, with the default of 008, adjustable from 000 to 999;

Press “UP or “Down” to modify the set IC card registration password.

Setting method: Press "Up" or "Down" key to increase or decrease the password value by 1. Press "UP" or "Down" for each 1s to increase or decrease by 1. When continuously increasing or decreasing by 10, press “UP"or "Down" to for each 1s to increase or decrease by 10.

6. PS1: unlock password, with the default of 06, adjustable from 01 to 99;

Press "UP"or "Down" to modify the set unlock password value.

Setting method: Press "Up" or "Down" key to increase or decrease the password value by 1. Press "UP"or "Down" for each 1s to increase or decrease by 1. When continuously increasing or decreasing by 10, press "UP"or "Down" to for each 1s to increase or decrease by 10.

7. CL1: IC card logout, with the default of 0, adjustable from 0 to 1;

Select CL1 for parameter list. Press “Set”, 000 flashes and it requires to enter the registration password. Enter the correct password and then press “Set” to execute the order. The CL1 flashes for 3 times and there is a buzz sound, which means that the logout is completed. In case of three times of entering wrong password, it will exit and lock, and re-display the temperature inside the freezer.

■ USB data export

1. Plug in the USB disk to automatically export the temperature, alarm and event records of the machine. When the data export is started, the decimal point in the lower right corner of the right-most digital pipe on the display panel flashes. When the data export is completed, the decimal point is on without flashing. Unplug the USB disk and the decimal point is off.

2. System storage space can meet 15 years of data storage.

■ Notice

1. The "Set" key must be pressed for confirming the saving after each parameter value is set. In other cases, the modified value cannot be saved.
2. In the above parameter setting process, press the "Buzzing cancel" to return the last layer of parameter/exit the parameter setting, or exit the parameter setting with 20s of no pressing.

Display and Alarms

Connect the power supply for the box and switch the power switch to the “ON” position to enter into power-on state and make the display screen to show the temperature inside the box.

Working status prompt of the display panel:

“Locked” light on: all settings are locked to prevent misoperation;

“Run” light on: the refrigeration system is in operation;

“Power” light on: the box has been powered by the main power supply;

“Alarm” light on: the box has a fault alarm;

Functions of the buttons:

1. “Set”: enter the unlock password to unlock the keyboard (long press for 5s) or confirm the settings;
2. “Up” and “Down”: select parameters or increase / decrease parameter values, and can be cycled when used for selecting parameters or parameter values;
3. “Silence”: temporarily silence the buzz or return to the previous-level parameters / exit parameters setting to return to display the temperature inside the box;
4. “Inquiry”: when the display panel is locked, press this key to query the device alarm code, input voltage and the ambient temperature where the equipment is used. The digital pipe displays the corresponding fault code, voltage and ambient temperature for 2s and then restores to display the temperature inside the box;

Alarm	Code	Status	Indication	Buzzer
High temperature alarm	E00	Displayed temperature \geq set temperature for high-temperature alarm, continuously for 1min	Alarm light flashes and overtemperature alarm light flashes	Buzzer alarm, remote alarm output
Low temperature alarm	E01	Displayed temperature \leq set temperature for low-temperature alarm, continuously for 1min	Alarm light flashes and overtemperature alarm light flashes	Buzzer alarm, remote alarm output
Too high ambient temperature	E02	Ambient temperature $\geq 35^{\circ}\text{C}$, continuously for 30s	Alarm light flickers	/
Main sensor fault	E10	In the case of main sensor fault	Alarm light flickers	Buzzer alarm
Fault of the ambient temperature sensor	E11	In the case of ambient temperature sensor fault	Alarm light flickers	Buzzer alarm
Condenser sensor fault	E12	In the case of condenser sensor fault	Alarm light flickers	Buzzer alarm
Battery disconnection	E20	Power switch turning off or battery connection line loosening	Alarm light flickers	Buzzer alarm
Reversed battery installation	E21	Detect that the reversed battery installation signal is low level	Alarm light flickers	Long buzzer sound alarm

Alarm	Code	Status	Indication	Buzzer
Low battery	E22	Lead-acid battery: when the battery is connected, after the battery is charged for 24 hours, the battery voltage is less than 10.5V	Alarm light flickers	/
		Lithium battery: when the battery is connected, after the battery is charged for 24 hours, the battery voltage is less than 9.0V	Alarm light flickers	/
Power failure alarm	E30	When the box is powered off	Alarm light and power indicator flash simultaneously	The buzz alarm sounds once every 3 seconds; the display panel does not display the temperature inside the box for 30 seconds; the normal display lasts for 5 seconds; the above-mentioned displays occur alternately; remote alarm output
Door opening alarm	E40	The door opening signal is detected for 5 minutes	Alarm light flickers	Buzzer alarm, remote alarm output
Dirty condenser fault	E50	When the condenser filter is blocked, or the condenser temperature is too high due to the high ambient temperature	Alarm light flickers	Buzzer alarm

 Caution

- A flashing alarm cannot be cancelled unless the malfunction is eliminated. The buzzing alarm can be temporarily silenced for 30 minutes by pressing the “Silence” key . However, if the problem persists, the buzzer alarm will resume after 30 minutes.
- When using the freezer, the battery switch must be turned on to charge the battery.
- When there is a power outage, the battery sustains the temperature display. If the battery voltage is insufficient, the temperature display will turn off.
- While the battery is still capable of providing power to display, the temperature display can be turned off by unplugging the power cord and turning off the battery control switch.

Automatic alarm recovery time setting

- When the unit is in alarm mode, you may press the “Silence” key to stop the buzzing of the alarm. (The remote alarm cannot be cancelled).
- If the condition persists, the buzzer alarm will resume automatically after 30 minutes.

Remote alarm terminal

• The remote alarm terminal is installed on the right side of the freezer's engine cabin, and the alarm signal will be output by this terminal. The load capacity of the terminal is DC 30V, 2A.

• Contact output:

The remote alarm terminal is divided into: Normally open, normally closed, common terminal. Users may select normal open or normal close according to their own requirements.

• Standard RS485 port can be used to transmit freezer temperature data to customer's software for monitoring.

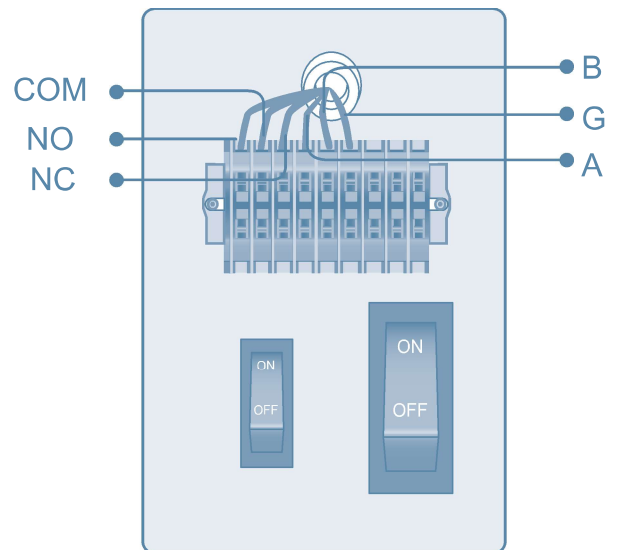

Cleaning and Maintenance

Cleaning of components

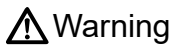

Warning

- To prevent electric shock or injury to operators, the AC power supply to the freezer must be disconnected completely prior to any repair and maintenance work is being performed.
- During any repair maintenance work, do not inhale sample particles or aerosols near the equipment as this may harmful.

Cleaning the freezer

- Clean the unit once a month.
- Use a dry cloth to wipe away loose dust inside and outside of the freezer. If the unit is dirty, use a clean cloth soaked with a neutral detergent solution.
- Using a dry cloth to wipe away any residual detergent solution.
- Do not pour water directly onto the exterior or into the interior of the unit. Water can damage the electrical insulation thereby causing a malfunction.
- Compressors and other mechanical parts are hermetically sealed. They do nt need lubrication.
- Clean frost and ice off the unit once a month. Also, clean the condenser filter once a month.

Clean the condenser filter

When the cooler panel shows an alarm signal for “Hot Condenser”, the alarm light flashes. The filter still be cleaned once a month. If the filter is clogged, it will affect the refrigeration efficiency and reduce the product’s lifespan.

To clean the filter, follow the procedure below:

1. Remove the front grill cover.
2. Pull out the filter screen.
3. Use water to wash the filter screen.
4. After the filter screen is dry, reinstall It back in its original position and close the cover.
5. If the “hot Condenser” light is on before cleaning, check the light to make sure that it shuts off after cleaning.

If it does not shut off, please contact service personnel.



Filter screen
Compartment grating

■ Defrosting on the inner wall

Frost and ice can form between the door gasket and frame to form an air gap, which can decrease the refrigeration effect of the unit. Use the provided plastic scraper to remove excess frost.

To defrost the unit, follow procedure below:

1. Turn off any backup refrigeration system if applicable.
2. Remove the samples from the unit that need to be defrosted. Move them to another unit or a container for temporary storage.
3. Turn off the power supply.
4. Open the outer door and inner doors to let the unit thaw for a period of time.
5. Use a dry cloth to soak up any water on the floor of the unit before restarting the unit.
6. Load the samples back into the unit after it reaches the set temperature.
7. Turn on the backup refrigeration system if present.



Caution Do not remove the frost by knife, screwdriver or other sharp tools.

■ Battery maintenance

- During continuous power-on operation of the box, please detect the battery level every 15 days. If low battery level is detected, please make sure that the battery switch is in the “ON” position to make the battery charged. When charging the battery for one week continuously, re-test the battery level. Under normal circumstances, the battery should be sufficient at this time. If the battery level is still low, it is recommended to replace the rechargeable battery.
- The battery is a kind of consumables and its service life is about 2 to 3 years. If the battery has been used for more than 3 years, it may fail to give an alarm in case of power failure.

■ Scrapping of the freezer

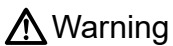

Warning

- If the box is left unused for a long time in an unsupervised area, make sure that no child can get access to it and the door is not completely closed.
- Scrapping of the box shall be carried out by professional personnel. Be sure to dismantle the door to prevent suffocation, etc.
- Disposal of discarded freezer shall be conducted by the relevant personnel. Dismantle the door to prevent occurrence of accidents such as suffocation.

Recycle of Rechargeable Battery

When the battery reaches end of life, contact a local recycling organization to dispose of the battery.

Location of the battery

The battery is for the power outage alarm. It is located inside the control box on the right side of the unit.

- ! • There are high voltage components in the control box. To prevent electric shock, only a qualified technician or engineer should open the cover.

Removal of the battery

1. Turn off the unit and unplug the power cord from the socket.
2. Remove side panel by removing screws.
3. Use a screwdriver to remove the 4 screws on the cover of the control box.
4. Unplug the connecting terminals from battery.
5. Remove the bracket that fastens the battery. Then remove the battery.
6. Follow regulations to recycle or properly dispose of battery.

- ⊘ • When changing the battery, make sure that the brown wire connects to the positive pole of the battery and that the blue wire connects to the negative pole of the battery.
- The polarity must not be reversed. Incorrect polarity can damage the computer's motherboard and prevent the battery from being charged.

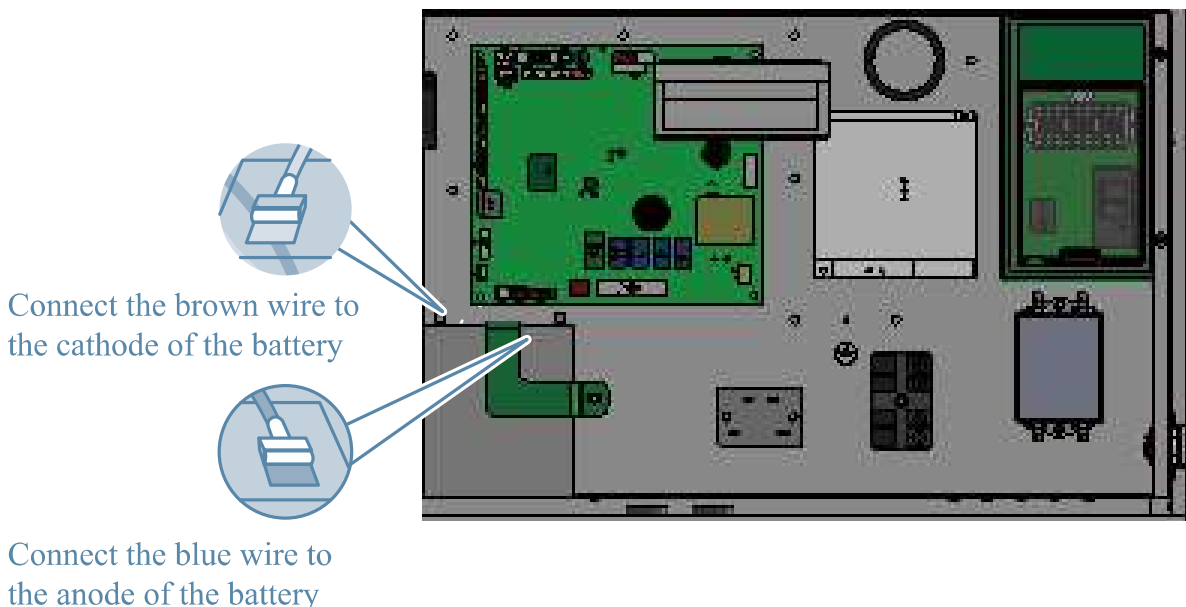

Optional components

■ CO₂ and LN₂ auxiliary cooling system

For installation and operation of the backup cooling system, please refer to the user's manual provided with the system.

Caution

Please purchase steel cylinders fitted with a siphon, The siphon can be used to siphon fluids that flow out from the bottom of the steel cylinders.

Warning

- The location of any equipment using CO₂/LN₂ must be in a well ventilated area. Increased CO₂ in the air may be harmful and even fatal. If the ventilation is poor, another method should be considered in order to ensure a safe working environment.
- CO₂/LN₂ cylinders should be adequately secured. Unsecured tanks may present a safety risk.
- The temperature of liquid CO₂/LN₂ is extremely low, which could cause frostbite. When replacing the cylinder, always wear appropriate personal protective equipment.

■ Wireless cold chain module

With wireless communication as the medium, the wireless cold chain module achieves exchange and data synchronization, management synchronization, operation synchronization and information synchronization between cryopreservation box sample library and sample library system.

Storage shelf, storage case

If the unit is used to store small samples, storage racks and boxes provide more efficient use of internal space.

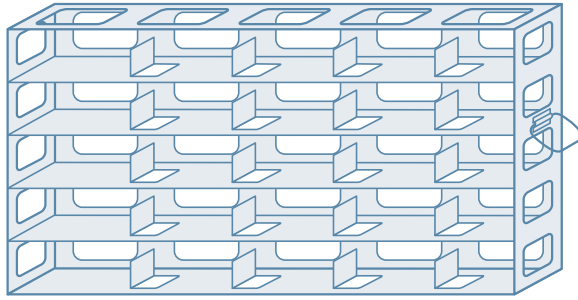

A-type storage shelf (side-draw type)

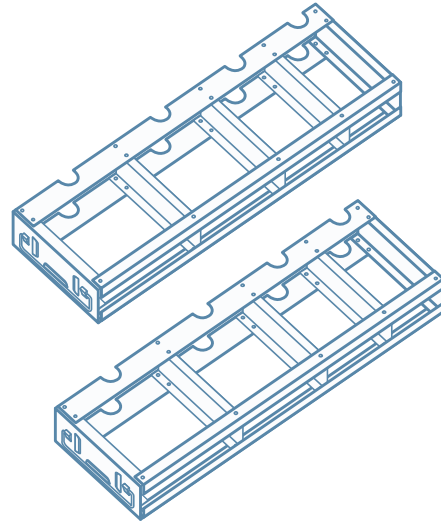

B-type storage shelf (drawer type)

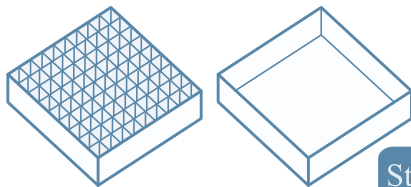

Storage case

Model	Storage Rack (A/B, optional)		Storage box
	Specification	Quantity	Quantity
DW-86L100J	5x3	4	60

Trouble Shooting



Please take below chart as reference for some common malfunction.

Fault	Troubleshooting solution
Start failure of the box	Is the power connection correct and is the power switch in “ON” position?
	Is the power voltage too low?
	Check whether there is an input voltage externally.
Poor cooling	Is ambient temperature too high?
	Check whether the inner door is closed tightly. Is the outer door is closed? (Frost between the box and the door gasket may damage the sealing of the door)
	Is the condenser filter screen clogged?
	Is the temperature set correctly?
	Is the box away from the direct sunlight?
	Is the box close to the heat source?
	Are the rubber cover and insulation material for test hole are installed and placed correctly?
Noise	Is the box installed on the solid and flat ground?
	Does the box enclosure contact with other articles?
	Is the box leveled by horizontal stand bar?

Refrigeration principle and circuit diagram

Refrigeration schematic diagram

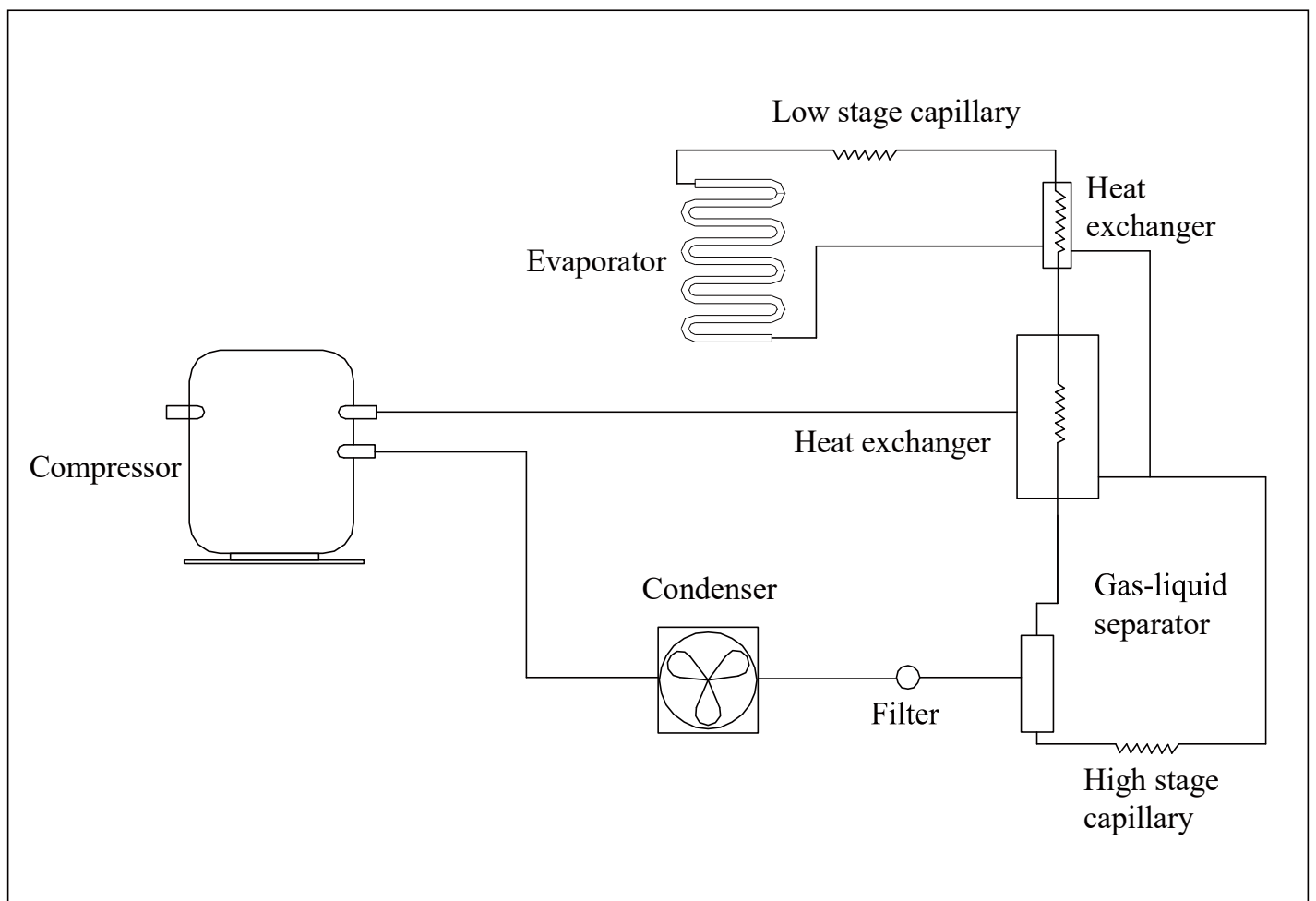

Circuit diagram

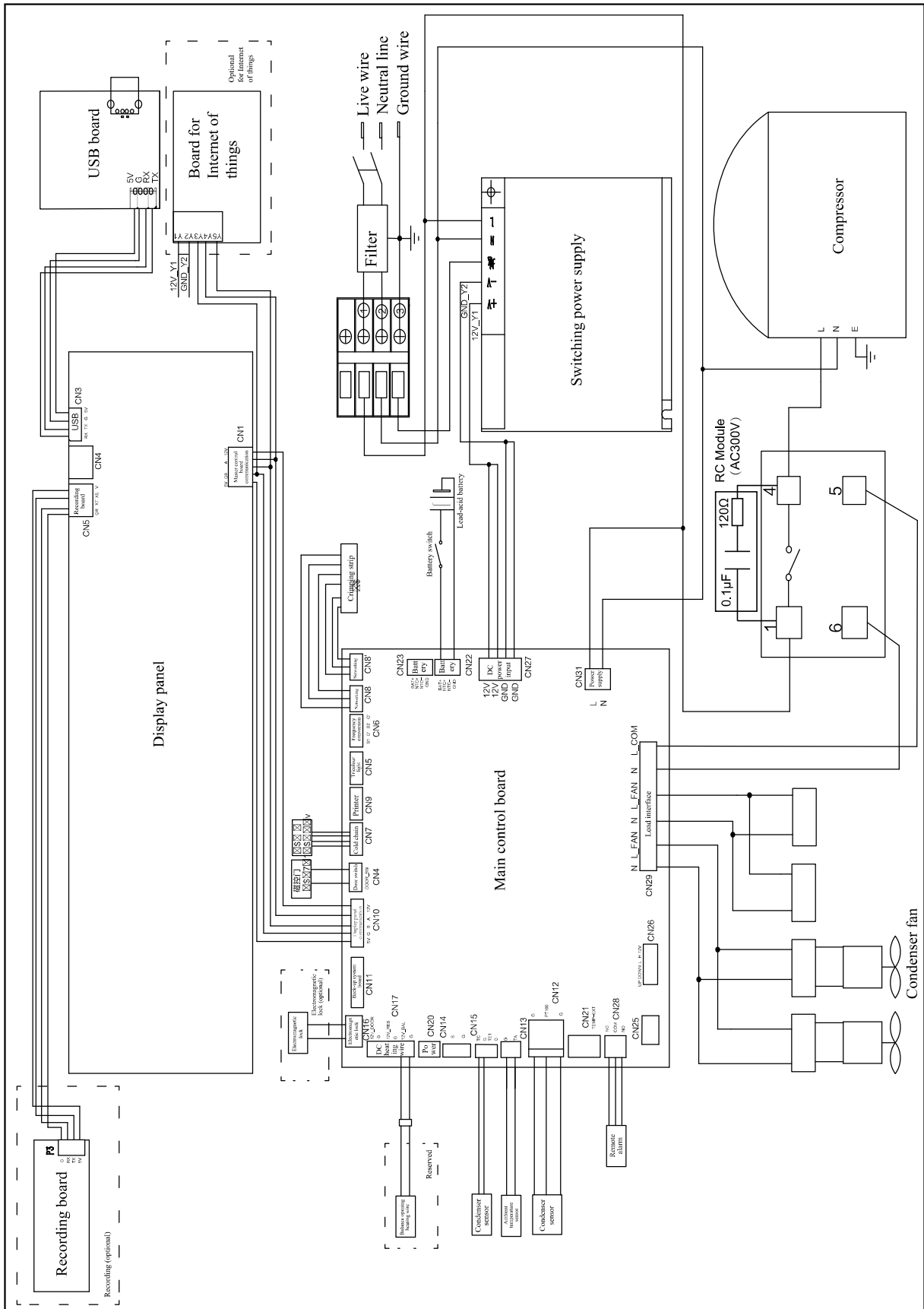

Accessory Packing List

■ Specification

Name	Medical cryopreservation box
Model	DW-86L100J
External dimension WxDxH (mm)	770x660x810
Enclosure / inner wall	Pure-polyester baking finish coated steel plate
Outer door	Pure-polyester baking finish coated steel plate
Inner door	Stainless steel
Shelf	Stainless steel
Test hole	1
Thermal insulation	VIP + polyurethane foam
Compressor	Hermetically sealed
Evaporator	Copper tube
Condenser	Micro-channel type
Refrigerant	HC refrigerant (without CFC)
Temperature controller	Microprocessor controller
Temperature display	Digital display
Noise	46.8dB(A)
Temperature sensor	Platinum resistor (Pt100)
Alarm device	High/low temperature alarm, sensor fault alarm, power failure alarm, dirty condenser alarm, ambient temperature alarm, low battery alarm and door open alarm
Remote alarm terminal battery	Maximum load: DC 30V, 2A Rechargeable battery, DC12V, automatic charging
Foaming Cabinet	HFO-1233zde
USB	Standard
Software version	V2

Note: The company lays emphasis on technological innovation, and the product parameters are subject to changes without prior notice.

Technical data

Model	Ambient temperature (°C)	Electric protection type	Temperature range (°C)	Rated voltage (V)	Rated frequency (Hz)
DW-86L100J	1/1	I	-40~-86	220-240	50

Model	Effective volume (L)	Input power (W)	Power consumption (KW/24H)	Weight (Kg)	External dimension WxDxH (mm)
DW-86L100J	100	680	5.5	108	770x660x810

Packing List

Name	Quantity	DW-86L100J
Warranty Card/Installation and Commissioning Manual		1/1
User manual/Position Installation Methods		1/1
Plastic bag		1
Ice scraper		1
Key		4
Position limiter		2

Certificate of Quality

checker:

Manufacturer: Qingdao Haier Biomedical Co., Ltd.

Address: Haier Industrial Park, Economic Technology Development
Zone, Qingdao P.R. China

Web: www.haierbiomedical.com

Revision Date: 03/2020

Version: 1st, 2020

Dedicated code: 027050

V13026